

LTspice IV Getting Started Guide

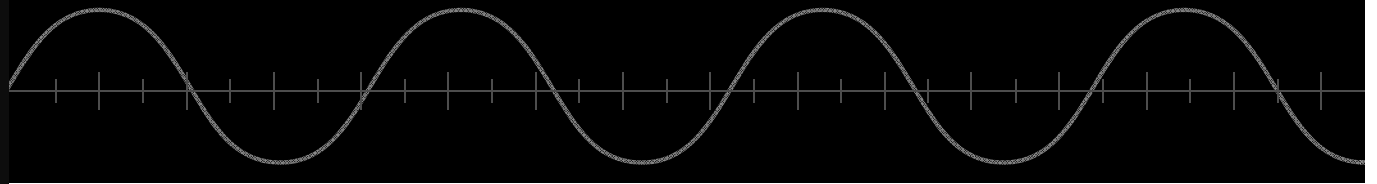

Benefits of Using LTspice IV

- ◆ Stable SPICE circuit simulation with Outperforms pay-for options
 - ◆ Unlimited number of nodes
 - ◆ Schematic/symbol editor
 - ◆ Waveform viewer
 - ◆ Library of passive devices
- ◆ Fast simulation of switching mode power supplies (SMPS) LTspice is also a great schematic capture
 - ◆ Steady state detection
 - ◆ Turn on transient
 - ◆ Step response
 - ◆ Efficiency / power computations
- ◆ Advanced analysis and simulation options
 - ◆ Over 1100 macromodels of Linear Technology products
 - ◆ 500+ SMPS
 - ◆ Not covered in this presentation

How Do You Get LTspice IV

- ◆ Go to <http://www.linear.com/LTspice>
- ◆ Left click on Download LTspice IV
- ◆ Register for a new MyLinear account to receive updates if you have not done so already

LTspice IV

LTspice IV is a high performance SPICE simulator, schematic capture and waveform viewer with enhancements and models for easing the simulation of switching regulators. Our enhancements to SPICE have made simulating switching regulators extremely fast compared to normal SPICE simulators, allowing the user to view waveforms for most switching regulators in just a few minutes. Included in this download are LTspice IV, Macro Models for 80% of Linear Technology's switching regulators, over 200 op amp models, as well as resistors, transistors and MOSFET models.

- [Download LTspice IV \(Update October 8, 2011\)](#)
- [LTspice Users Guide](#)
- [LTspice Getting Started Guide](#)
- [Using Transformers in LTspice IV](#)
- [LTspice Demo Circuit Collection](#)
- [View upcoming LTspice seminars](#)

Follow LTspice on Twitter! 

View the LTspice Video Channel 

Getting Started

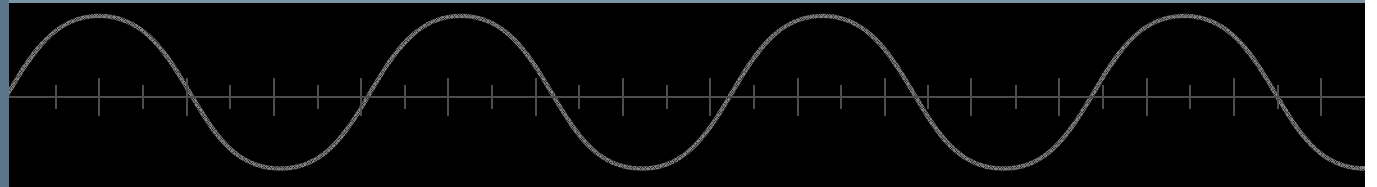

Getting Started using LTspice IV

- ◆ Use one of the 100s of demo circuits available on linear.com
 - ◆ Reviewed by Linear Technology's Factory Applications Group
- ◆ Use a pre-drafted test fixture (JIG)
 - ◆ Provides a good starting point
- ◆ Use the schematic editor to create your own design
 - ◆ LTspice contains macromodels for most LTC power devices

Demo Circuits on linear.com

- ◆ Go to <http://www.linear.com>
- ◆ Enter root part number in the search box (e.g. 3411)
- ◆ Select Simulate Tab on the left side
- ◆ Follow the instructions provided

If you do not find a demo circuit of interest, use a pre-drafted test fixture – covered next

Download LTspice

Download Demo Circuit

Complete list of demo circuits available at www.linear.com/democircuits

OVERVIEW

PACKAGING

ORDER INFO

SIMULATE

DEMO BOARDS

TECH SUPPORT

Simulate

LTspice IV is a powerful, fast and free simulation tool, schematic capture and waveform viewer with enhancements and models for improving the simulation of switching regulators. To download LTspice IV and other FREE simulation tools, please visit our [Design Simulation](#) page.

To launch a ready to run LTspice demonstration circuit for this part:

- **Step 1:** If you have not installed LTspice on this computer, download and install [LTspice IV](#)
- **Step 2:** Once LTspice is installed, click on the link(s) below to launch the simulation
 - [LTC3411 Demo Circuit - 1.25A, 4MHz, Synchronous Step-Down DC/DC Converter \(3.3V to 1.0V @ 1A\)](#)
- **Step 3:** If LTspice IV does not automatically open after clicking the link above, you can instead run the simulation by right clicking on the link and selecting "Save Target As". After saving the file to your computer, start LTspice and open the demonstration circuit by selecting 'Open' from the 'File' menu

To explore other ready to run LTspice demonstration circuits, please visit our [Demo Circuits Collection](#).

Demo Circuit

- ✓ Designed and Reviewed by Factory Apps Group

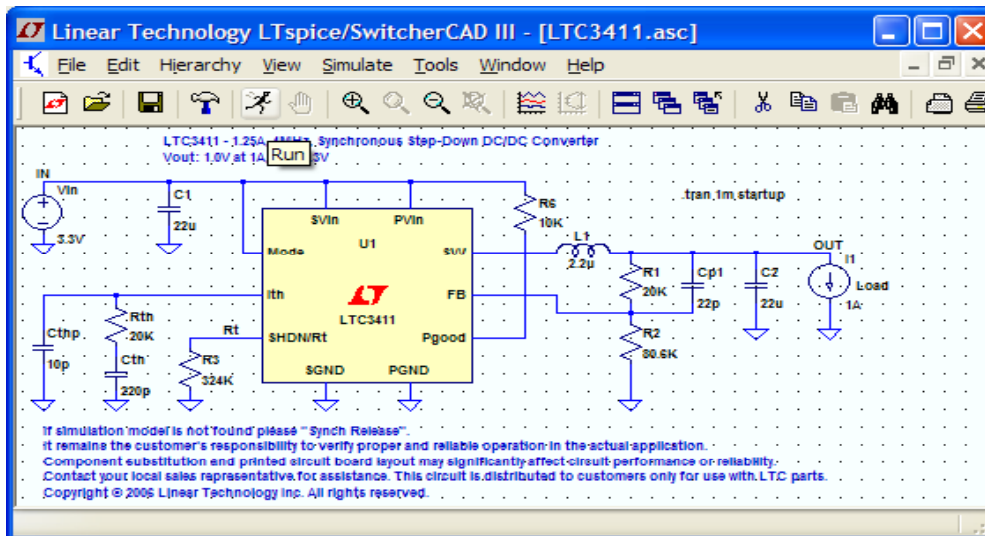

To run a demo circuit jump to the [Run and Probe a Circuit in LTspice](#) section

- ◆ It remains the customer's responsibility to verify proper and reliable operation in the actual application
- ◆ Printed circuit board layout may significantly affect circuit performance or reliability

Getting Started using LTspice IV

- ◆ Use one of the 100s of demo circuits available on linear.com
 - ◆ Reviewed by Linear Technology's Factory Applications Group
- ◆ Use a pre-drafted test fixture (JIG)
 - ◆ Provides a good starting point
- ◆ Use the schematic editor to create your own design
 - ◆ LTspice contains macromodels for most LTC power devices

Pre-Drafted Test Fixture (JIG)

- ◆ Used for testing models during development
- ◆ Provides a draft starting point
 - ◆ Not reviewed by Linear Technology's factory applications team

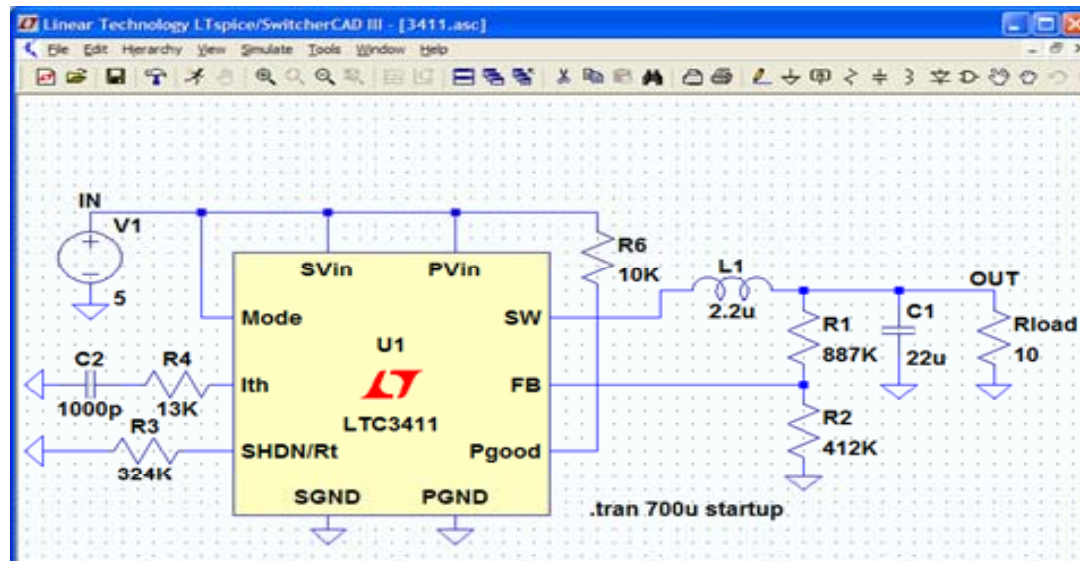

- ◆ It remains the customer's responsibility to verify proper and reliable operation in the actual application
- ◆ Printed circuit board layout may significantly affect circuit performance or reliability

Start with a New Schematic

New Schematic

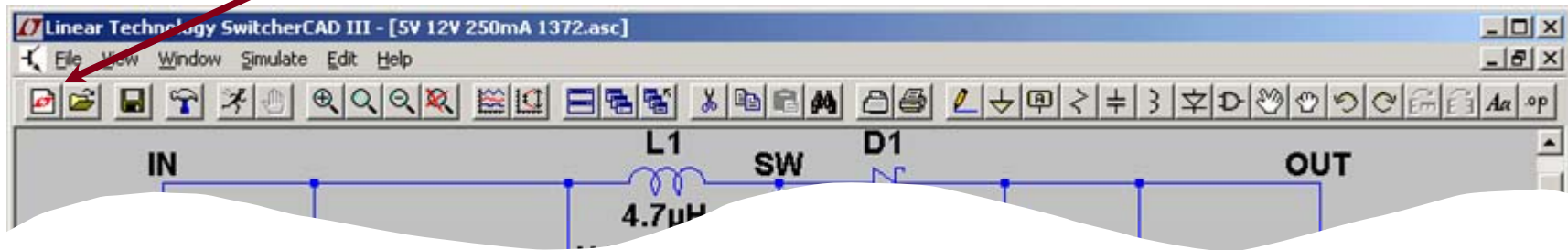

- ◆ Left click on the **New Schematic** symbol in the Schematic Editor Toolbar

Add a Macromodel & Opening Test Fixture

Add Component

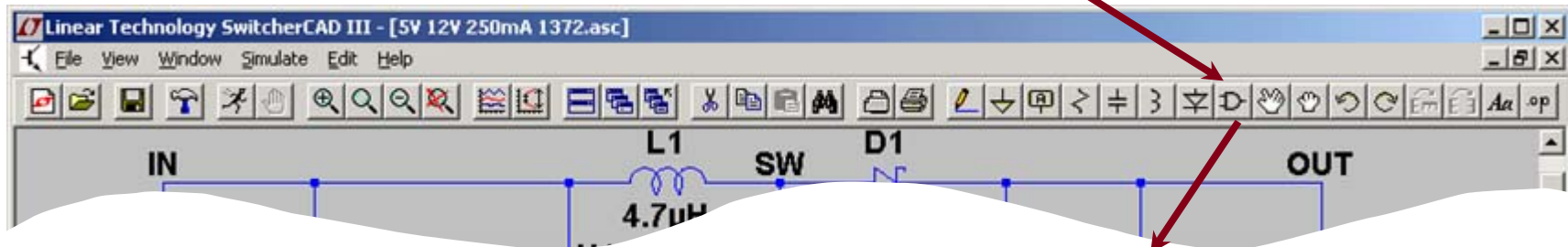

- ◆ Left click on the **Component** symbol in the Schematic Editor Toolbar
- ◆ Enter “root” part to search for the model (e.g. 3411)
- ◆ Left click on **Open this macromodel's test fixture**

To run a test fixture, jump to the [Run and Probe a Circuit in LTspice](#) section

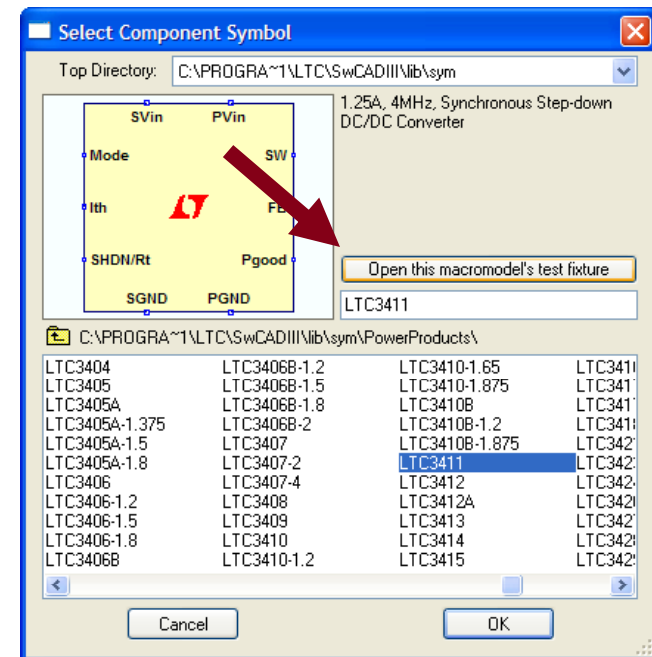

Getting Started using LTspice IV

- ◆ Use one of the 100s of demo circuits available on linear.com
 - ◆ Reviewed by Linear Technology's Factory Applications Group
- ◆ Use a pre-drafted test fixture (JIG)
 - ◆ Provides a good starting point
- ◆ Use the schematic editor to create your own design
 - ◆ LTspice contains macromodels for most LTC power devices

Draft a Design Using the Schematic Editor

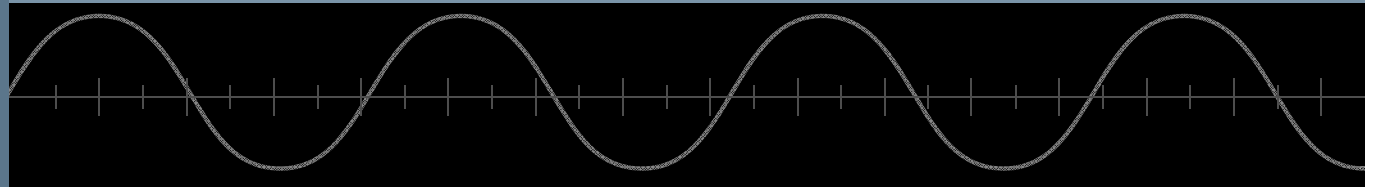

Start with a New Schematic

New Schematic

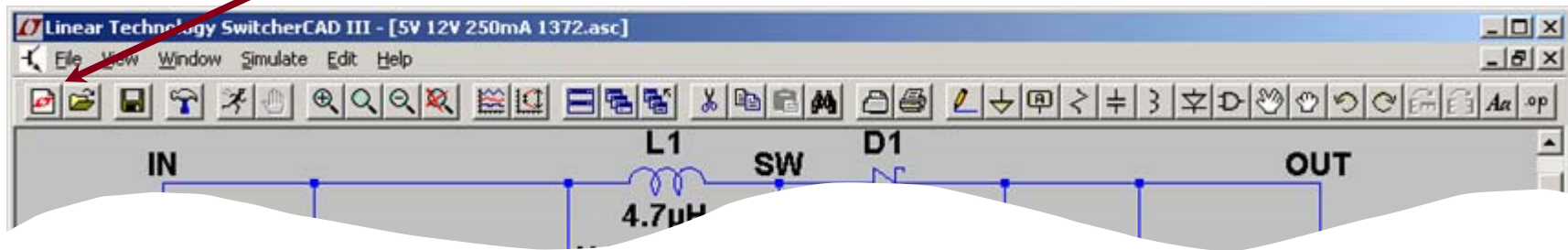

- ◆ Left click on the **New Schematic** symbol in the Schematic Editor Toolbar

LTspice is also a great schematic capture

Add a Linear Technology Macromodel

Add Component

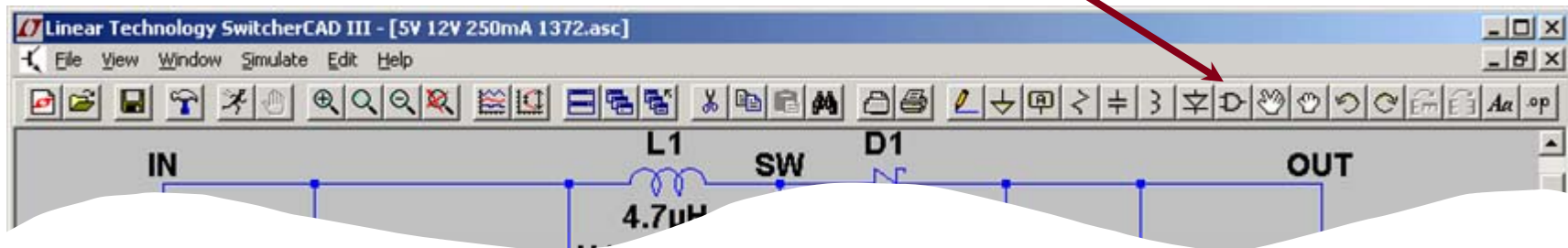

- ◆ Left click on the **Component** symbol in the Schematic Editor Toolbar
- ◆ Enter “root” part to search for the model (e.g. 3411)
- ◆ Left click on **OK**

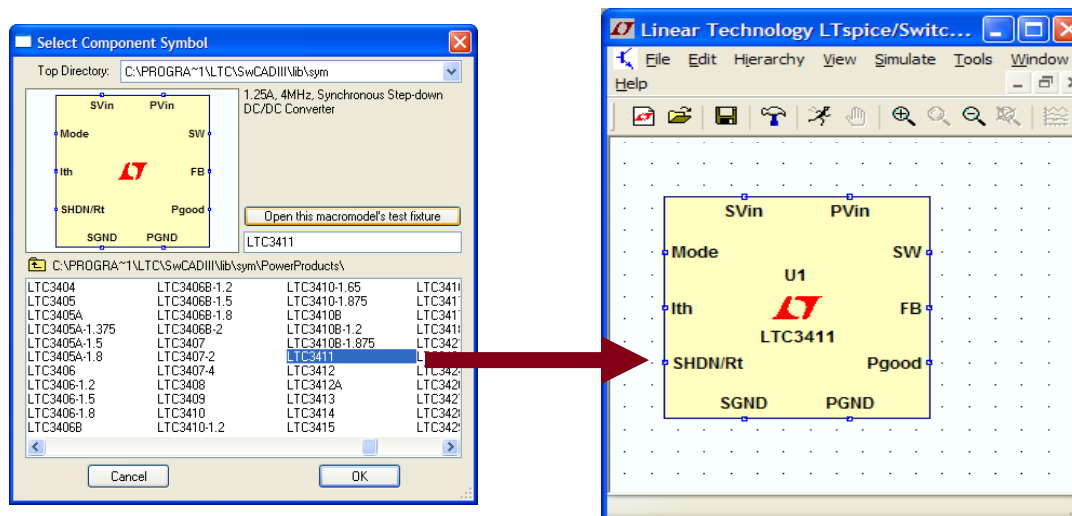

Getting the Latest Datasheet

- ◆ Use the macromodel's shortcuts to download the *Datasheet* as a reference for your design
 - ◆ Hold Ctrl key and right click (*Ctrl – right click*) over the LT macromodel's symbol
 - ◆ Left click on Go to Linear website for datasheet on the dialog box that appears

You can also open the macromodel's test fixture as a draft starting point

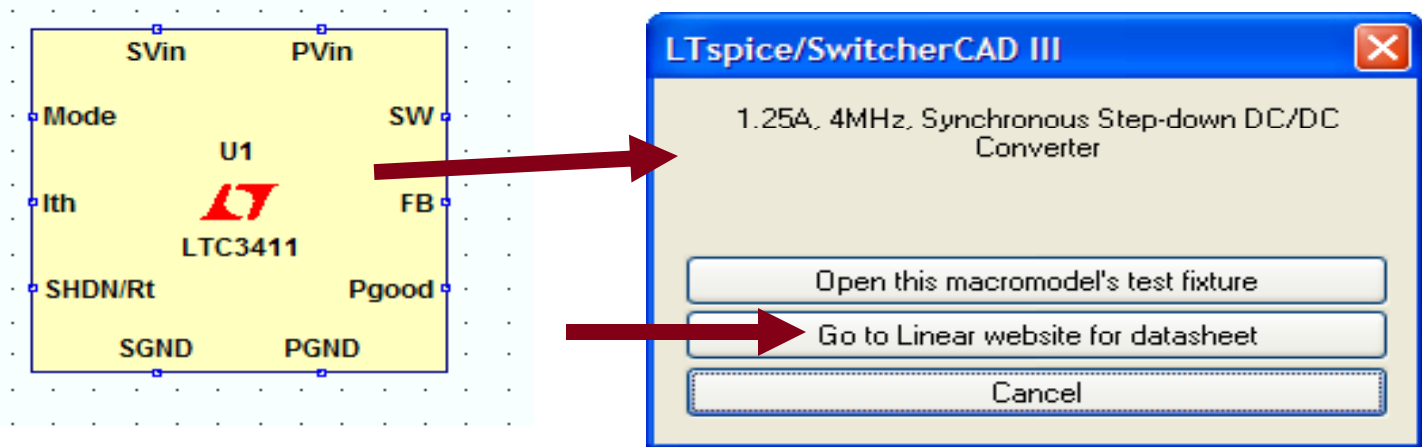

Adding Circuit Elements

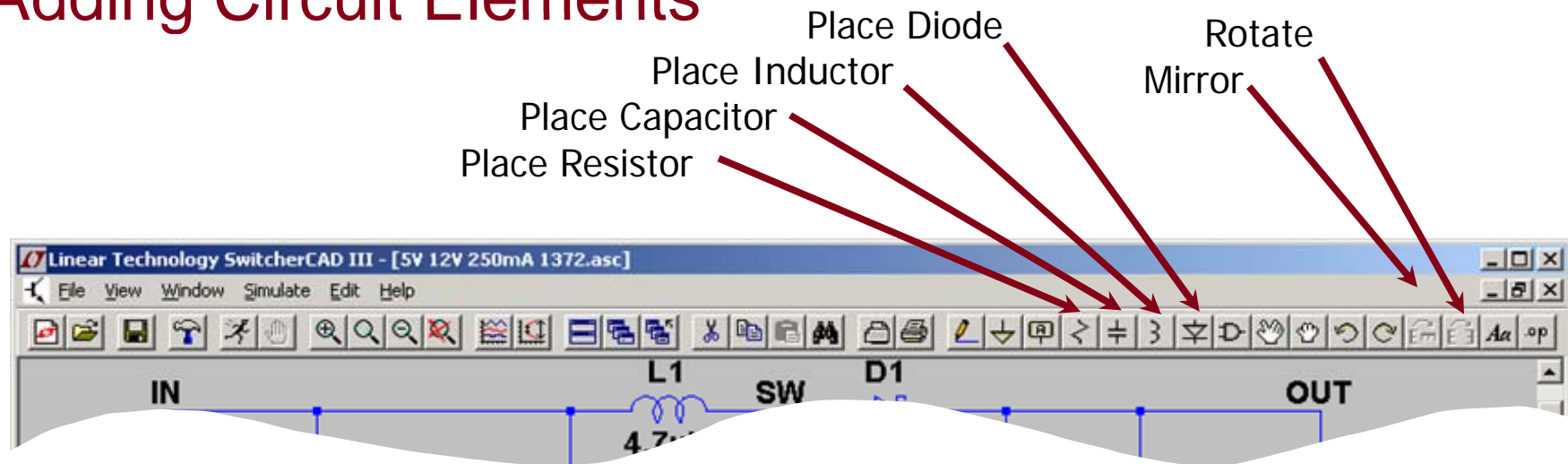

- ◆ Left click on the desired *component* in the Schematic Editor Toolbar
- ◆ Left click on **Rotate** or **Mirror** to adjust orientation
 - ◆ Alternate you can also use Ctrl – R and Ctrl – M key shortcuts
- ◆ Move the mouse to the position you want to place it
- ◆ Left click to place it

To cancel or quit a component type, click the right mouse button

Adding Sources, Loads & Additional Circuit Elements

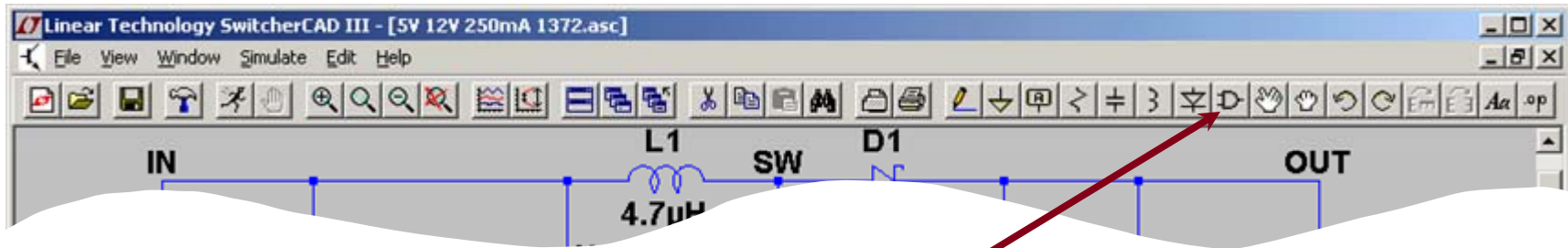

- ◆ Left click on the **Component** symbol in the Schematic Editor Toolbar
- ◆ Search directory structure for desired circuit element (e.g. load and voltage)
- ◆ Left click on **OK**
- ◆ Move the mouse to the position you want to place it
- ◆ Left click to place it

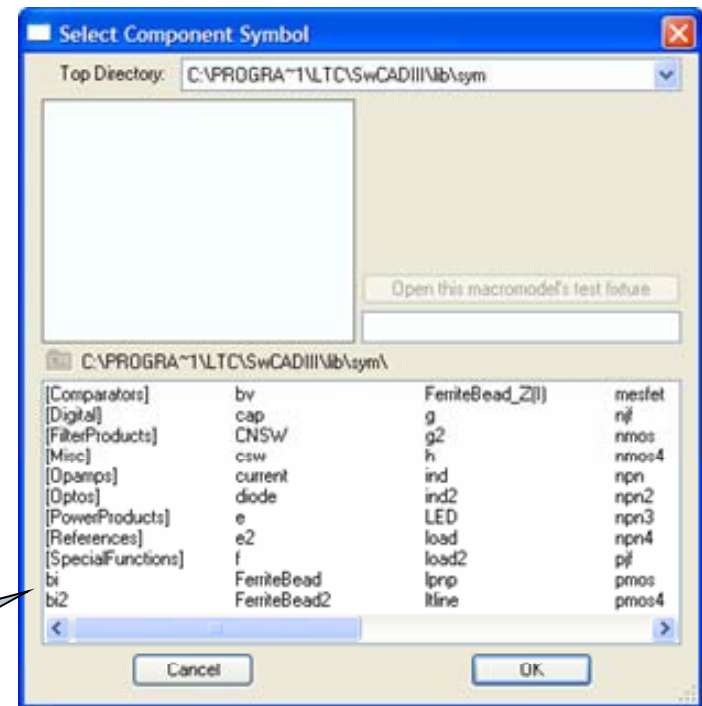

Additional Circuit Elements
Like Sources and Loads

Highlights of Additional Circuit Elements

- ◆ Left click on the **Component** symbol in the Schematic Editor Toolbar for a directory of additional circuit elements:
 - ◆ Arbitrary behavioral source
 - ◆ Voltage dependent voltage
 - ◆ Current dependent current
 - ◆ Voltage dependent current
 - ◆ Current dependent voltage
 - ◆ Independent current source
 - ◆ JFET transistor
 - ◆ Mutual inductance
 - ◆ MOSFET transistor
 - ◆ Lossy transmission line
 - ◆ Bipolar transistor
 - ◆ Voltage controlled switch
 - ◆ Lossless transmission line
 - ◆ Uniform RC-line
 - ◆ Independent voltage source
 - ◆ Current controlled switch
 - ◆ Subcircuit
 - ◆ MESFET transistor
 - ◆ ...many more

Drawing Lines and Labeling Nodes

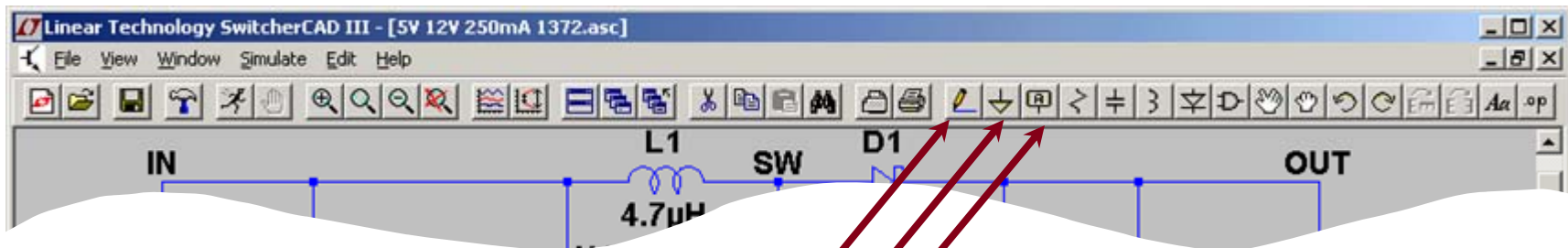

Draw Wire
Place Ground
Label Node

Do not forget to place a ground in your design, it is required for simulation!

◆ Lines

- ◆ Left click on the Draw Wire in the Schematic Editor Toolbar
- ◆ Left click a blue box (terminal)
- ◆ Define the line's path with a left click over intermediate points
- ◆ Left click on another blue box (terminal)

Editing Circuit Elements

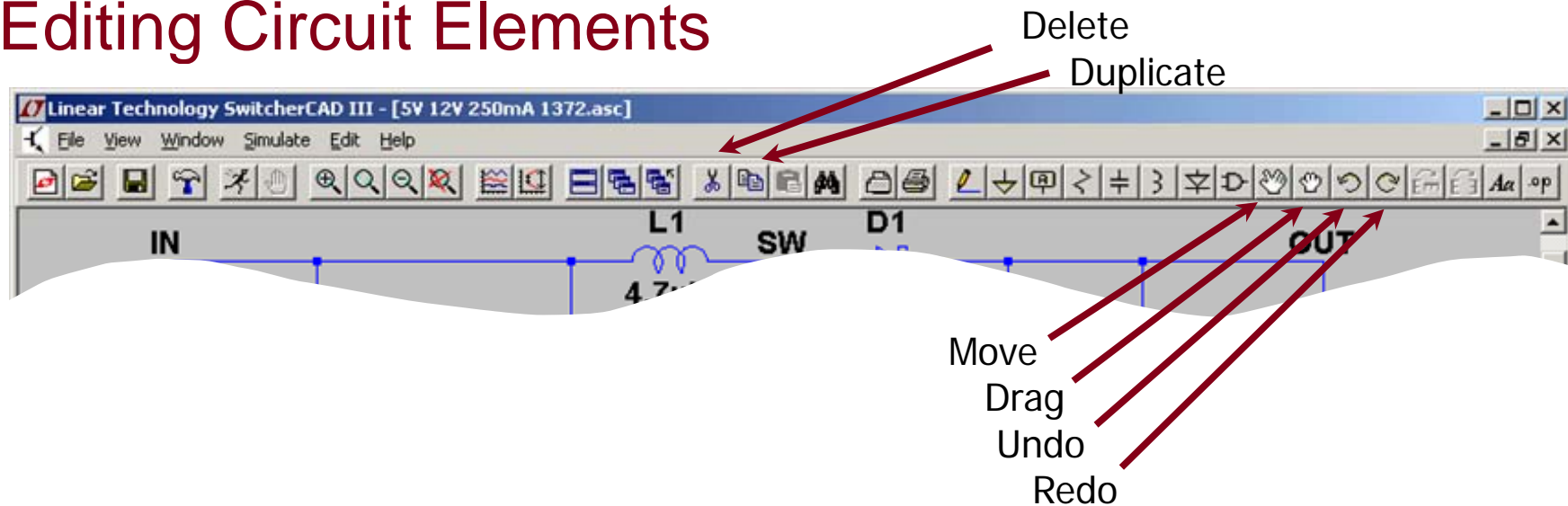

- ◆ Left click on the desired editing option
- ◆ Left click on the circuit element

To organize your layout, use the **Drag** option to move circuit elements around and to adjust lines between terminals

Editing Circuit Elements Attributes

- ◆ Right click on the component ***symbol*** to modify attributes

Resistor - R6

Manufacturer:

Part Number:

Resistor Properties

Resistance[Ω]:

Tolerance[%]:

Power Rating[W]:

Inductor - L1

Manufacturer: Coilcraft

Part Number: DO1608P-222

Show Phase Dot

Inductor Properties

Inductance[H]:

Peak Current[A]:

Series Resistance[Ω]:

Parallel Resistance[Ω]:

Parallel Capacitance[F]:

(Series resistance defaults to 1mΩ)

Capacitor - Cp1

Manufacturer:

Part Number:

Type:

Capacitor Properties

Capacitance[F]:

Voltage Rating[V]:

RMS Current Rating[A]:

Equiv. Series Resistance[Ω]:

Equiv. Series Inductance[H]:

Equiv. Parallel Resistance[Ω]:

Equiv. Parallel Capacitance[F]:

Mean Time Between Failures[hr]:

Parts Per Package:

- ◆ Right click on the text next to the component to edit the visible attribute and label
 - ◆ Pointer will turn into a text caret

Use Labels to Specify Units in Circuit Elements Attributes

- ◆ **K** = k = kilo = 10^3
- ◆ **MEG** = meg = 10^6
- ◆ **G** = g = giga = 10^9
- ◆ **T** = t = terra = 10^{12}
- ◆ **m** = M = milli = 10^{-3}
- ◆ **u** = U = micro = 10^{-6}
- ◆ **n** = N = nano = 10^{-9}
- ◆ **p** = P = pico = 10^{-12}
- ◆ **f** = F = femto = 10^{-15}

Important

- ◆ Use **MEG** to specify 10^6 , not *M*
- ◆ Enter **1** for 1 Farad, not *1F*

Circuit Elements Database

- ◆ Some components have an available database of manufacturers' attributes
 - ◆ Resistors, capacitors, inductors, diodes,
 - ◆ Bipolar transistors, MOSFET transistors, JFET transistors
 - ◆ Independent voltage and current sources
- ◆ To configure a component to a manufacturer's attributes
 - ◆ Right click on the component *symbol*
 - ◆ Left click on **Select...** or **Pick New...**
 - ◆ Left click on a selected device
 - ◆ Left click on OK

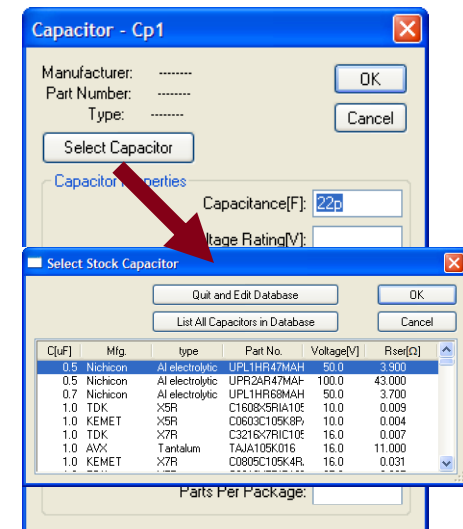
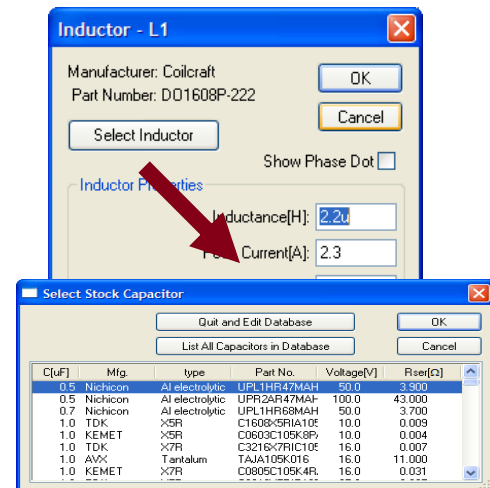

Editing Voltage Sources and Loads

- ◆ Voltage Source
 - ◆ Right click the voltage **symbol**
 - ◆ Enter **DC voltage value** and (optional) Series Resistance
 - ◆ Left click on OK
- ◆ Load (current)
 - ◆ Right click on the load **symbol**
 - ◆ Enter **DC current value**
 - ◆ Left click on OK

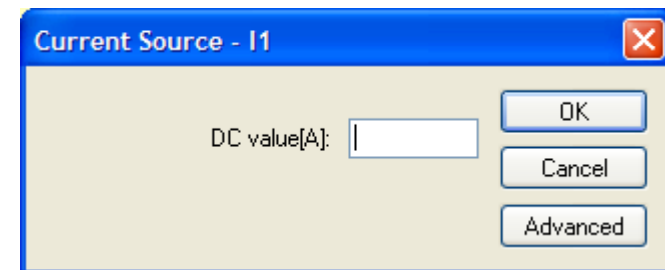
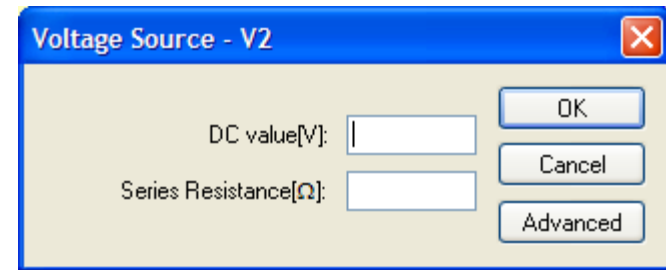

Summary of Schematic Editor Toolbar

The image shows a screenshot of the Linear Technology SwitcherCAD III schematic editor interface. The toolbar is highlighted with red arrows pointing to various icons, each labeled with its function. The schematic diagram below the toolbar shows a circuit with components labeled IN, L1 (4.7µH), SW, D1, and OUT.

- Place Circuit Element
- Place Diode
- Place Inductor
- Place Capacitor
- Place Resistor
- Label Node
- Place Ground
- Draw Wire
- Delete
- Duplicate
- Paste b/t Schematics
- Find
- Move
- Drag
- Undo
- Redo
- Rotate
- Mirror
- Place Comment
- Place SPICE directive

Run and Probe a Circuit

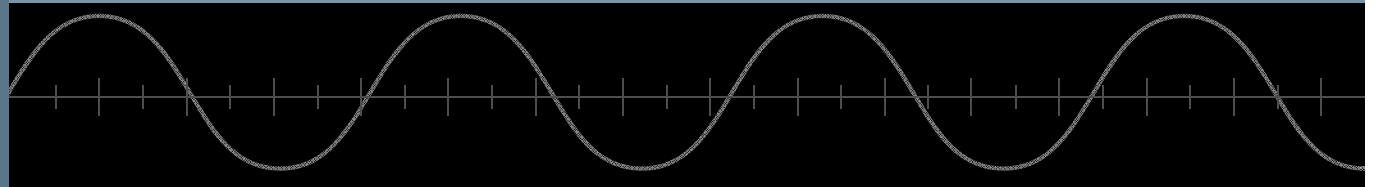

Simulation Commands

- ◆ To run a simulation, specify the type of analysis to be performed
- ◆ There are six different types of analyses:
 - ◆ Transient analysis
 - ◆ Small signal AC
 - ◆ DC sweep
 - ◆ Noise
 - ◆ DC transfer function
 - ◆ DC operating point
- ◆ Simulation commands are placed on the schematic as text
 - ◆ Called dot commands

More information on simulation and dot commands are available in LTspice IV User Guide

Editing Simulation Commands

- ◆ Left click on **Simulation** menu
- ◆ Left click on **Edit Simulation Cmd**
- ◆ As a starting point in a simulation
 - ◆ Left click on **Transient** tab
 - ◆ Enter a **Stop Time**
 - ◆ You may need to adjust this again later
- ◆ Select **OK**

Demo Circuits and Test Fixtures
have predefined Simulations
Commands

Edit Simulation Command

Transient | AC Analysis | DC sweep | Noise | DC Transfer | DC op pnt

Perform a non-linear, time-domain simulation.

Stop Time: 700u

Time to Start Saving Data:

Maximum Timestep:

Start external DC supply voltages at 0V:

Stop simulating if steady state is detected:

Don't reset T=0 when steady state is detected:

Step the load current source:

Skip Initial operating point solution:

Syntax: .tran <Tstop> [<option> [<option>] ...]

.tran 700u startup

Cancel OK

Running a Circuit

Run

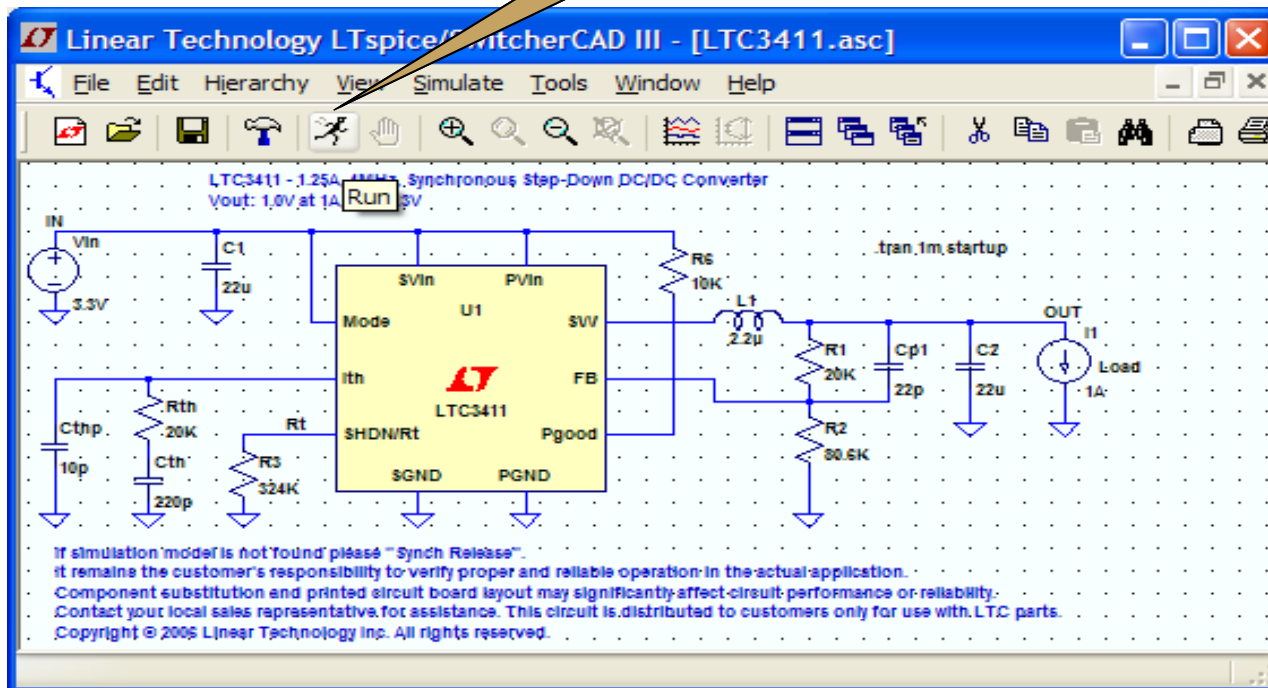

If model is not found please Sync Release
under Help menu to update LTspice

Probing a Circuit & Waveform Viewer

- ◆ Left click on any wire to plot the voltage on the waveform viewer

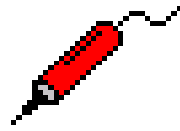

Voltage probe cursor

- ◆ Left click on the body of the component to plot the current on the waveform viewer
 - ◆ Convention of positive current is in the direction into the pin



Current probe cursor

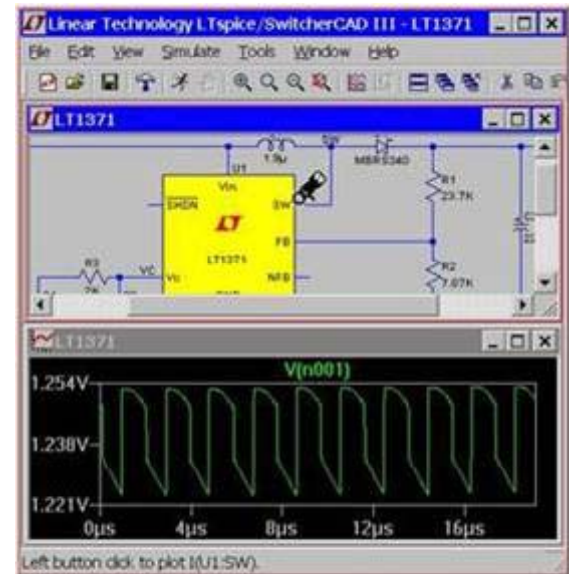
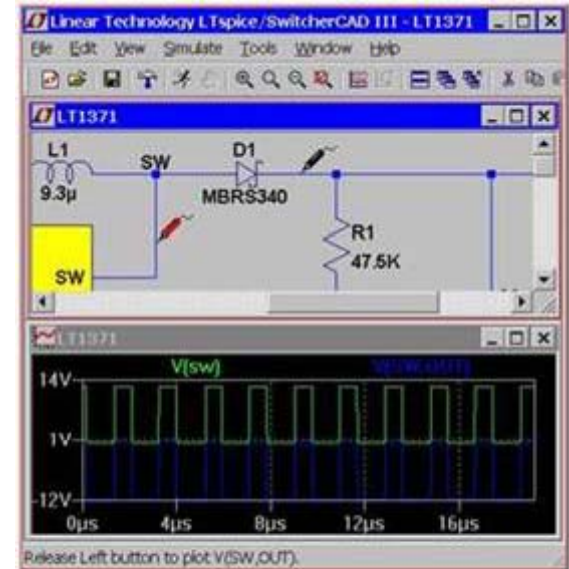

Probing a Demo Circuit and Test Fixture

- ◆ Demo Circuits and Test Fixtures have INs and OUTs clearly labeled to help you quickly select them
- ◆ To view the waveform left click on IN and OUT

Left Click
Here for
Input
Waveform

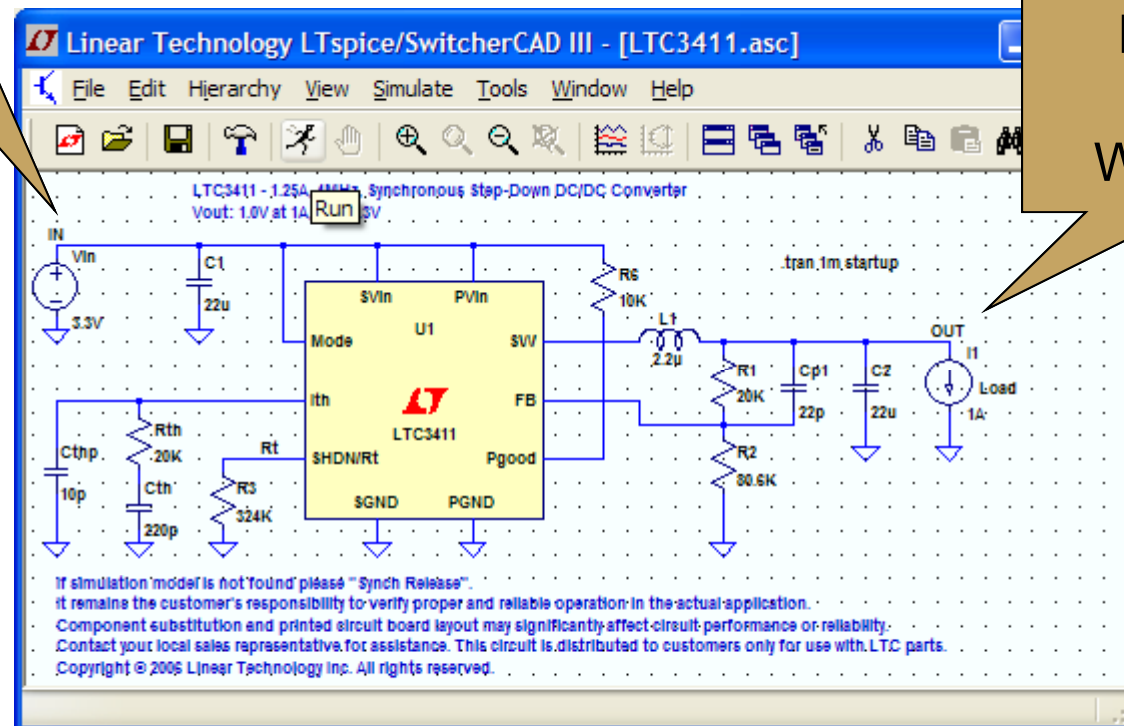

Left Click
Here for
Output
Waveform

Voltage Differences Across Nodes

- ◆ Left click and hold on one node and drag the mouse to another node
 - ◆ Red voltage probe at the first node
 - ◆ Black probe on the second

Differential voltages are displayed in the waveform viewer

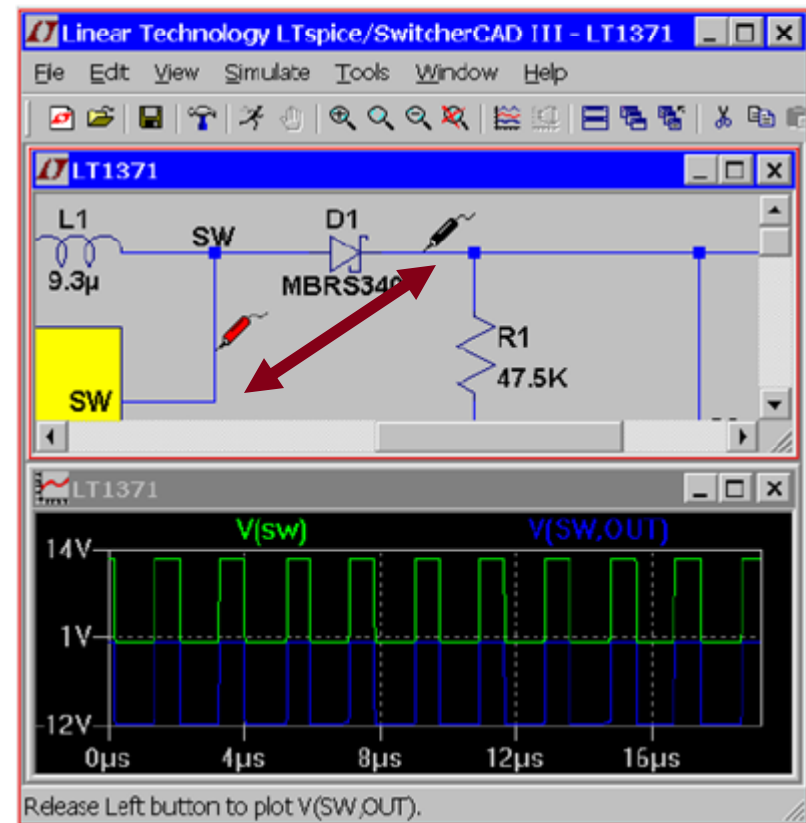

Plot Planes

- ◆ Multiple plot panes can be displayed on one window to allow better separation between traces permitting different traces to be independently autoscaled
 - ◆ Right click in the waveform pane
 - ◆ Select Add Plot Pane
 - ◆ Left click and hold to drag a label to a new plot pane

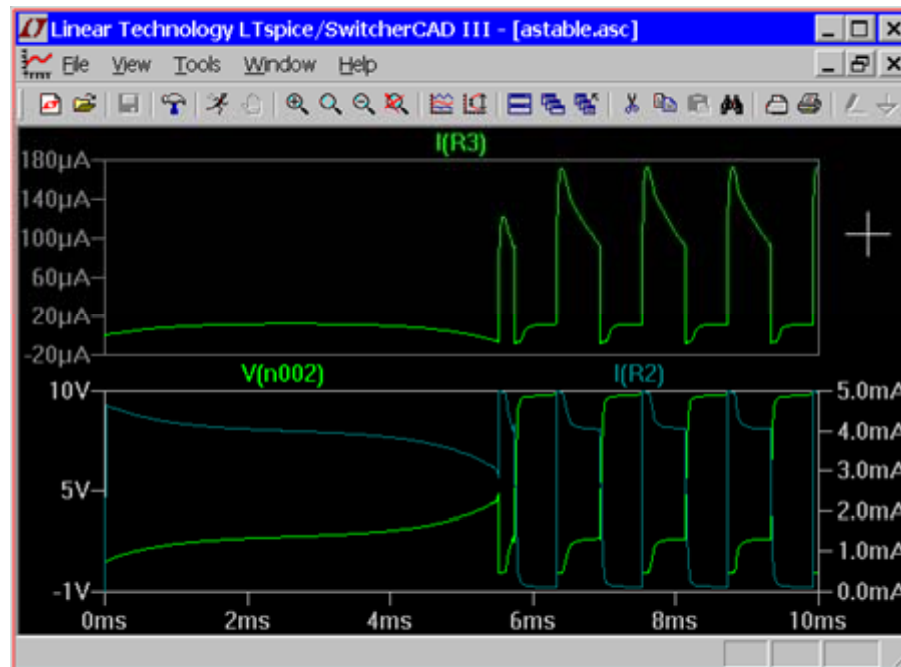

Zooming In and Out in the Waveform Viewer

- ◆ To zoom in
 - ◆ Left click and hold as you drag a box about the region you wish to zoom in then release
- ◆ To zoom out
 - ◆ Right click and select **Zoom to Fit** or **Zoom Back**

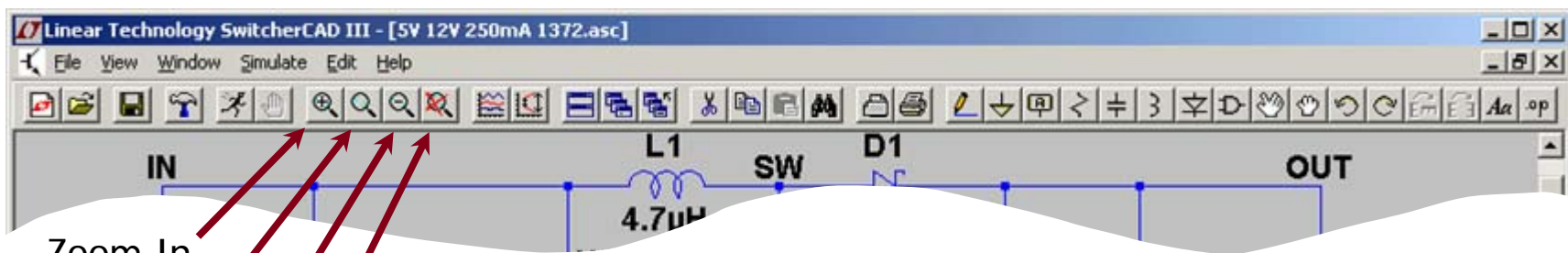
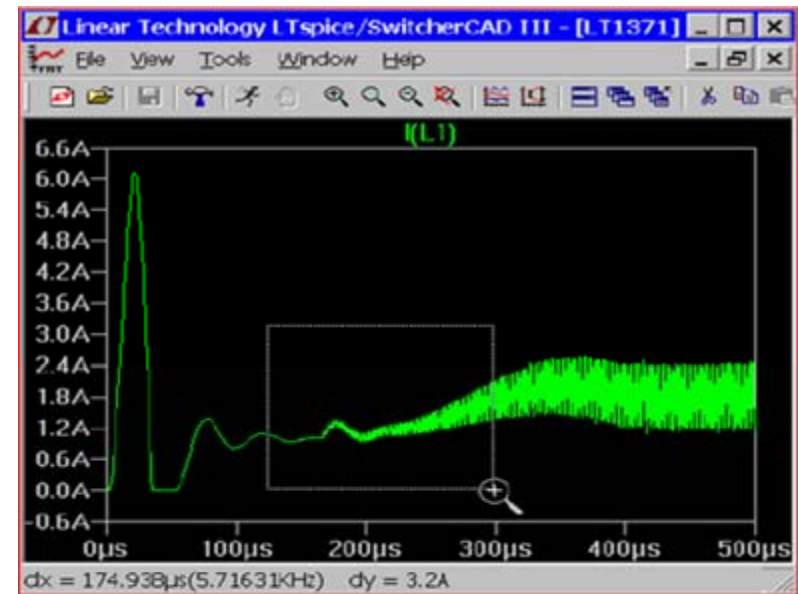

Zoom In
Pan
Zoom Out
Autoscale

Measuring V_{Ripple} , I_{Ripple} and Time (Frequency)

- ◆ Drag a box about the region you wish to measure (peak to peak over a period)
 - ◆ Left click and *hold* to drag a box over the portion of interest
- ◆ View the lower left hand side of the screen
 - ◆ To avoid resizing, shrink your box before you let go of the left mouse click or use the Undo command in the Edit menu

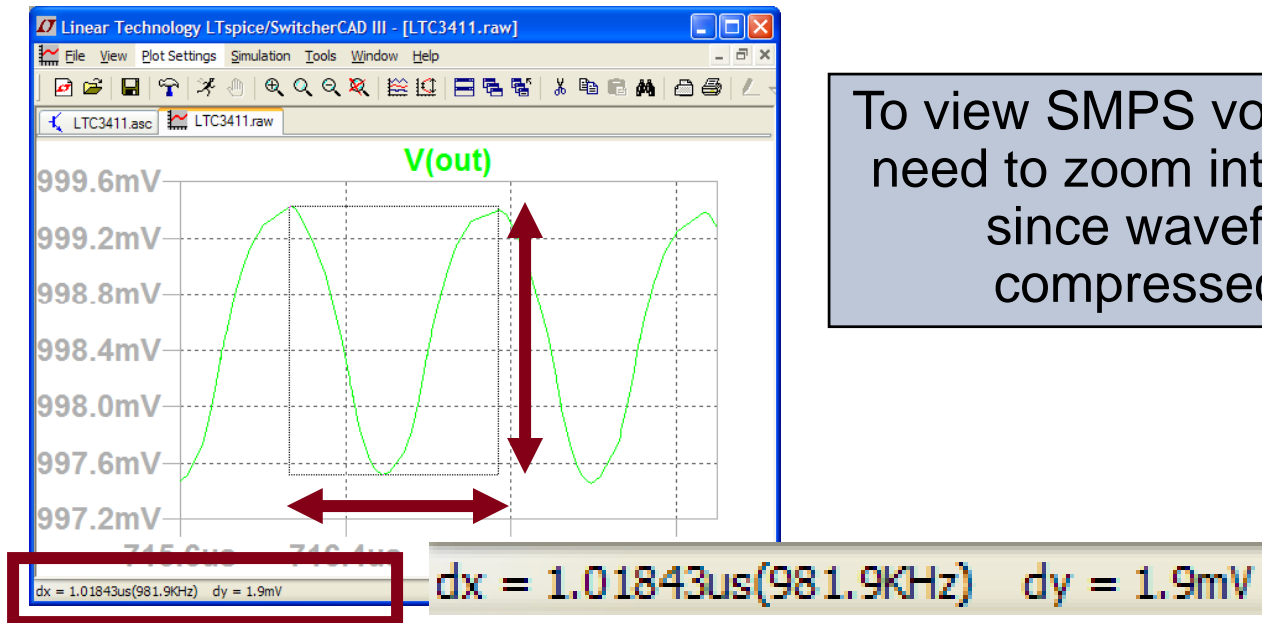

To view SMPS voltage ripple you will need to zoom into a narrow section since waveform is initially compressed to full range

Average/RMS Current or Voltage Calculations

- ◆ Hold down Ctrl and left click on the I or V ***trace label*** in the waveform viewer

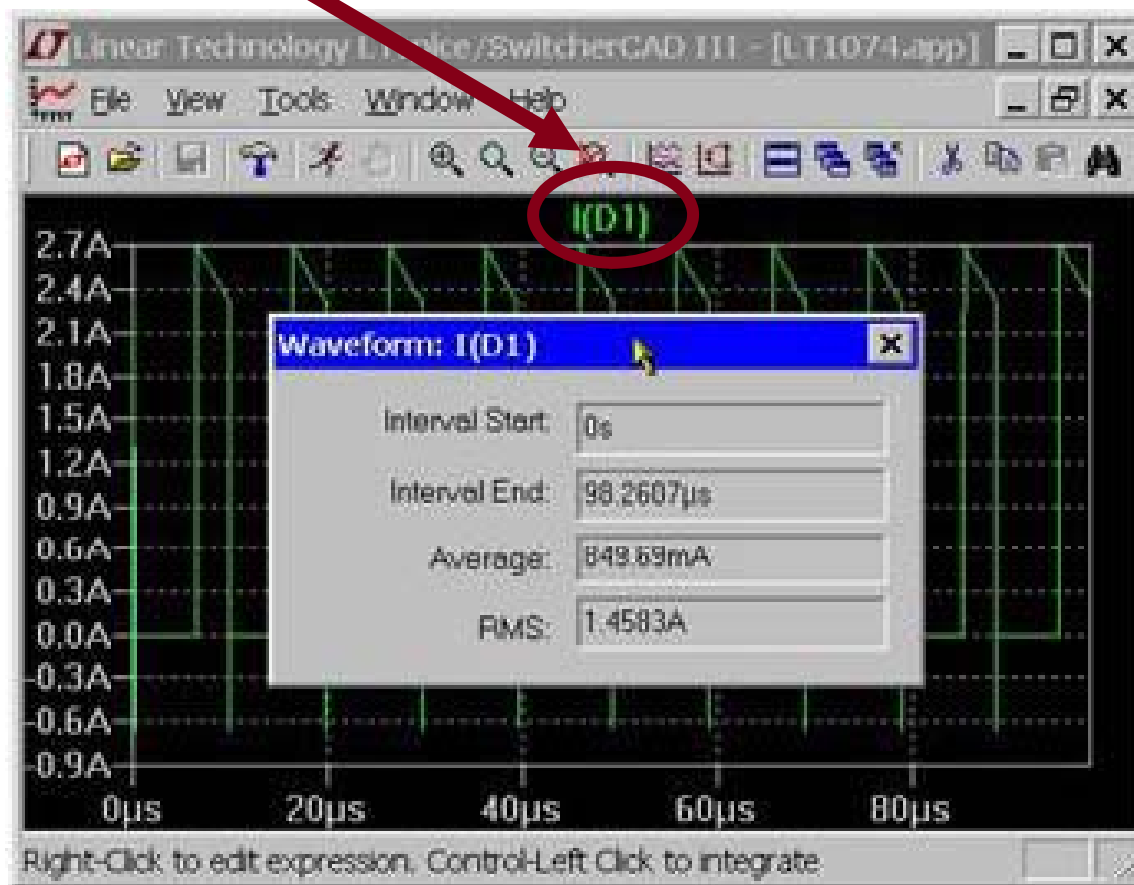

Instantaneous & Average Power Dissipation

◆ Instantaneous Power Dissipation

- ◆ Hold down the ALT key and left click on the symbol of the component
- ◆ Pointer will change to a thermometer
- ◆ Plotted in units of Watts

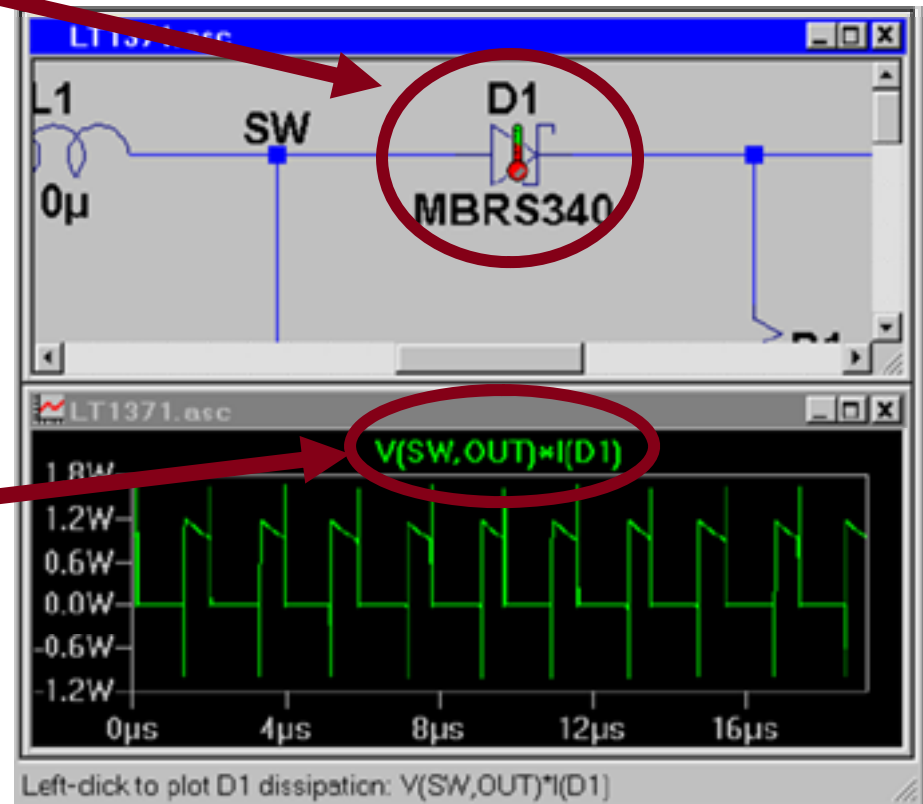

◆ Average Power Dissipation

- ◆ Hold down the Ctrl key and left click on the **trace label** power dissipation waveform

Generating a BOM and Efficiency Report

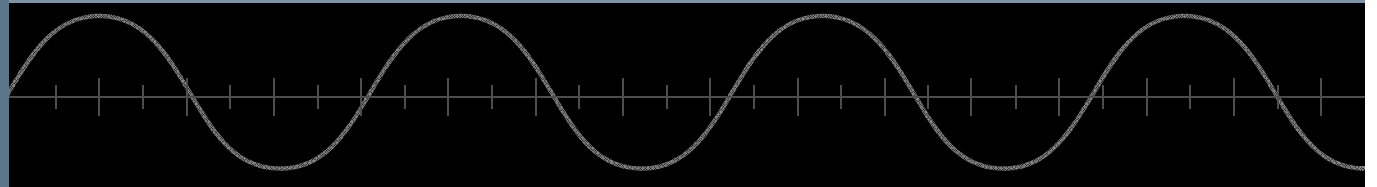

Bill of Materials (BOM)

- ◆ Left click on **View** menu
- ◆ Left click on **Bill of Materials**

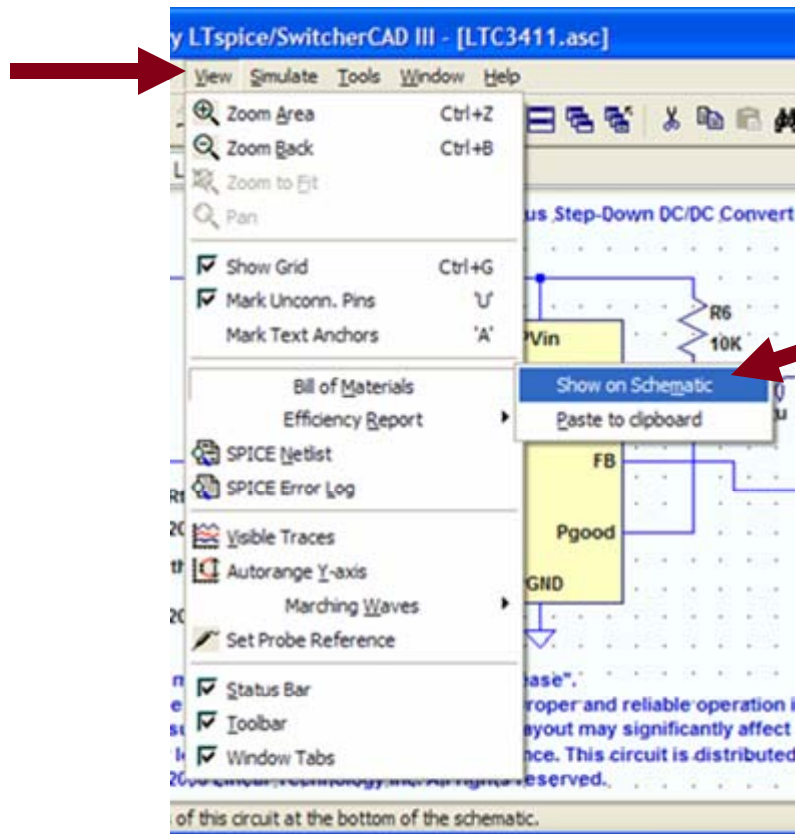

The screenshot shows the 'Bill of Materials' window in LTspice/switcherCAD III. The window displays a table of components with their reference designators, manufacturer names, part numbers, and descriptions. A red arrow points from the 'Bill of Materials' option in the View menu to this window.

Ref.	Mfg.	Part No.	Description
C1	TDK	C3225X5R0J226M	capacitor, 22uF, 6.3V
C2	TDK	C3225X5R0J226M	capacitor, 22uF, 6.3V
Cp1	--	--	capacitor, 22pF
Cth	--	--	capacitor, 220pF
Cthp	--	--	capacitor, 10pF
L1	Coilcraft	DO1608P-222	inductor, 2.2uH, 2.3A pk
R1	--	--	resistor, 20K
R2	--	--	resistor, 80.6K
R3	--	--	resistor, 324K
R6	--	--	resistor, 10K
Rth	--	--	resistor, 20K
U1	Linear Technology	LTC3411	integrated circuit

Computing Efficiency of SMPS Circuits

- ◆ Left click on **Simulate** menu
- ◆ Left click on **Edit Simulation Cmd**
- ◆ Left click on **Stop simulating if steady state is detected**
 - ◆ Automatically detect the steady state by checking the internal state of the macromodels
- ◆ Rerun simulation

Automatic detection of steady state may not work – steady state detection may be too strict or lenient

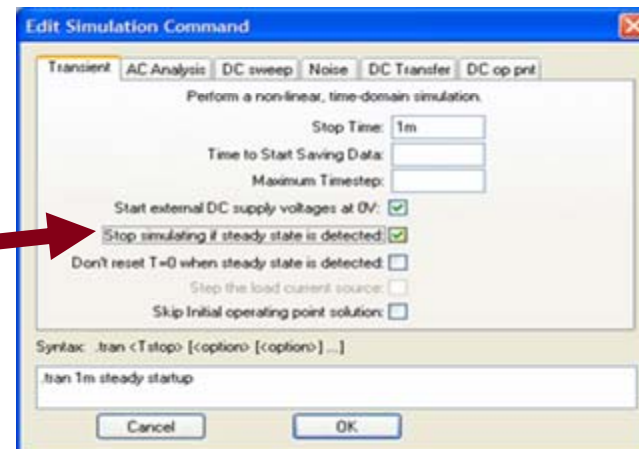
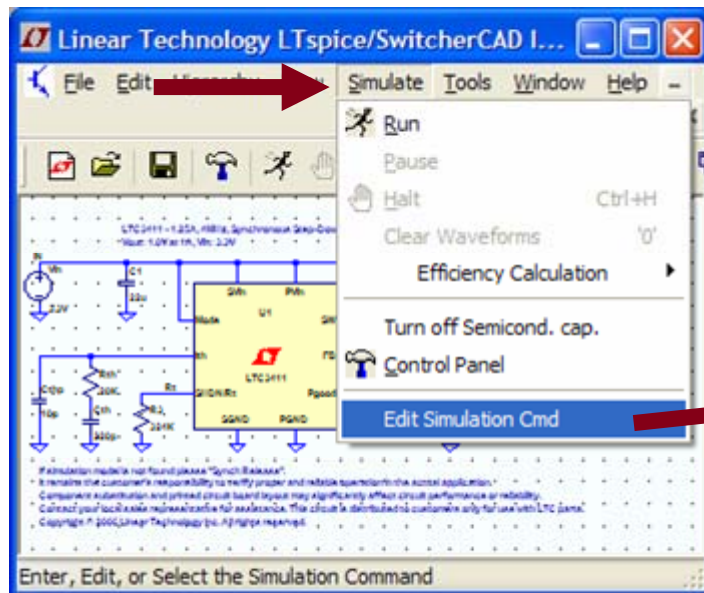

Viewing Efficiency Report

- ◆ Left click on **Simulate** menu
- ◆ Left click on **Efficiency Report**

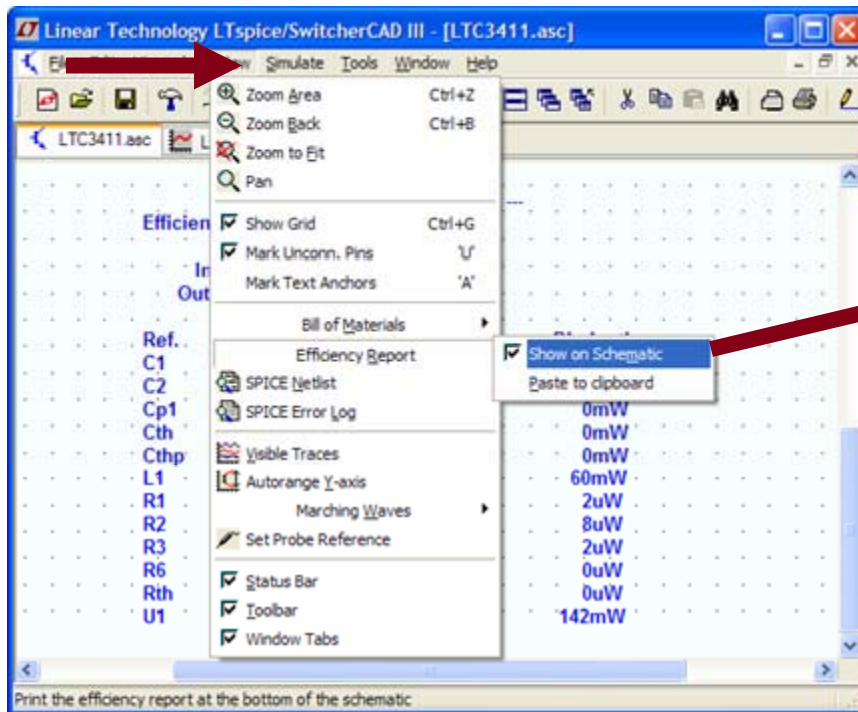

Efficiency: 83.1% --- Efficiency Report ---

Input: 1.2W @ 3.3V
Output: 997mW @ 999mV

Ref.	I _{rms}	I _{peak}	Dissipation
C1	0mA	0mA	0mW
C2	99mA	177mA	0mW
Cp1	0mA	0mA	0mW
Cth	0mA	0mA	0mW
Cthp	0mA	0mA	0mW
L1	1003mA	1176mA	60mW
R1	0mA	0mA	2uW
R2	0mA	0mA	8uW
R3	0mA	0mA	2uW
R6	0mA	0mA	0uW
Rth	0mA	0mA	0uW
U1	1003mA	1176mA	142mW

Simulate a Transient Response in a SMPS

Advanced Topic

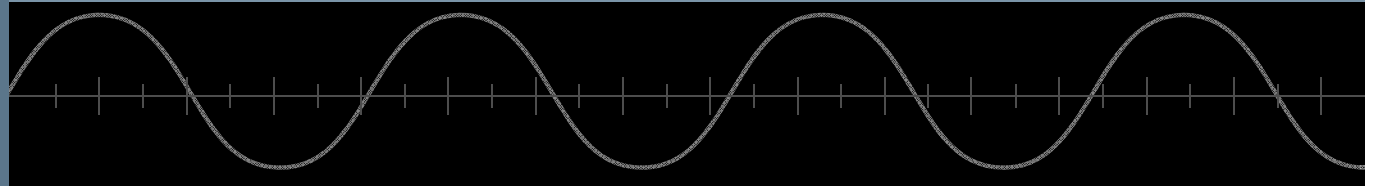

Use a Pulsed Function as a Transient Response Load

- ◆ Insert a current source load
 - ◆ Left click on the Component symbol in the Schematic Editor Toolbar
 - ◆ Select load (or load2) circuit element and configure as pulsed
 - ◆ Left click on OK
- ◆ Configure load as a pulsed function (covered next)
 - ◆ Steps current from initial to pulsed value and back
- ◆ Run and review results

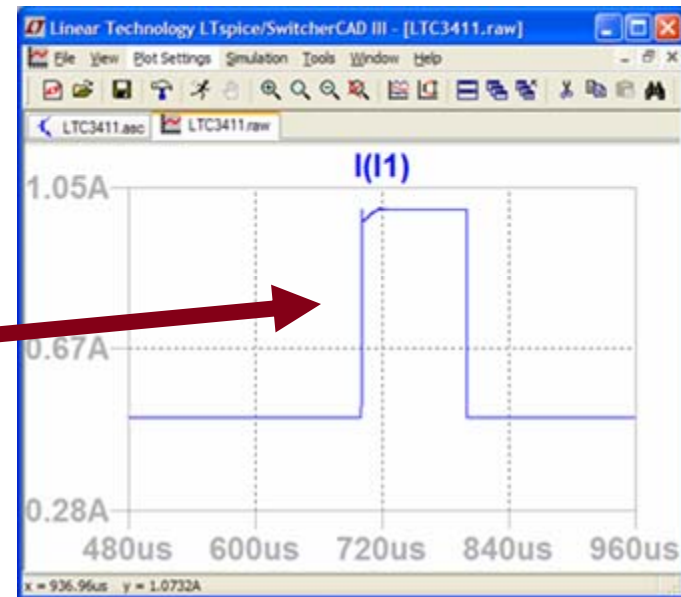
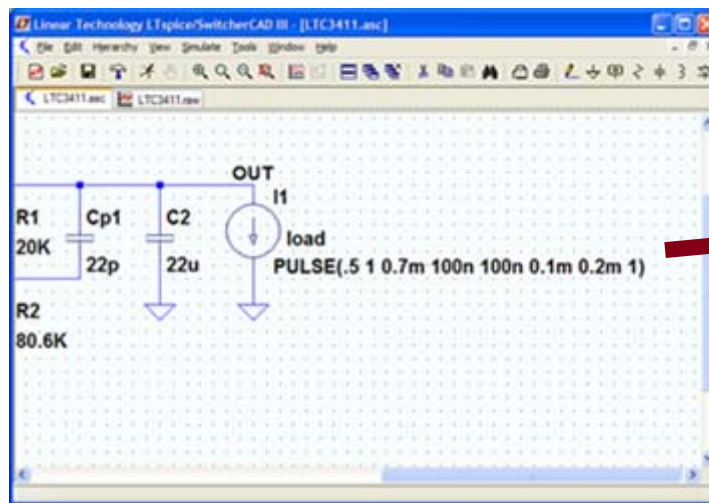

Configuring Load as a Pulse Function

- ◆ Right click on the load (or load2) component
- ◆ Select Pulse
- ◆ Modify the Attributes
 - ◆ I1 = Initial value
 - ◆ I2 = Pulsed Value
 - ◆ Tdelay = Delay
 - ◆ Tr = Rise time
 - ◆ Tf = Fall time
 - ◆ Ton = On time
 - ◆ Tperiod = Period
 - ◆ Ncycles = Number of cycles
 - ◆ Omit for free running

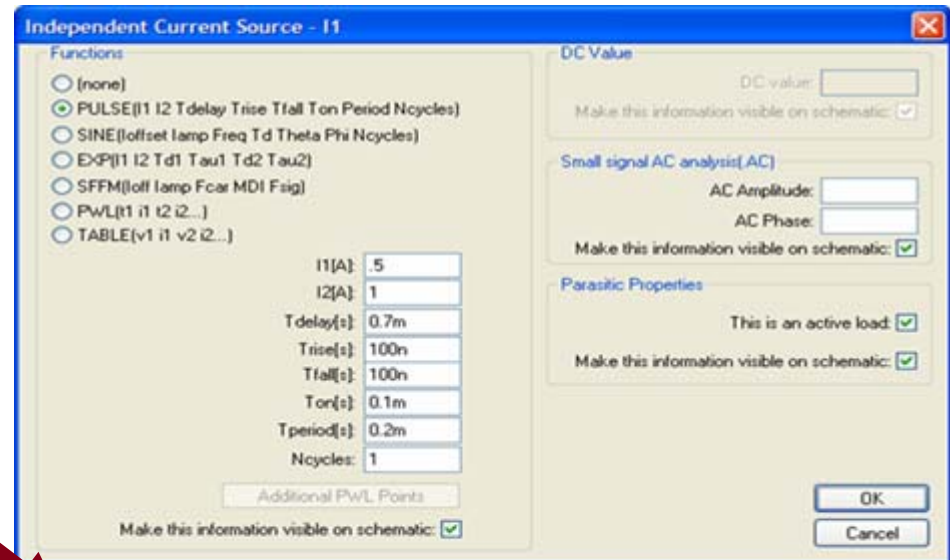

Tdelay needs to be adequate so that the device is in steady state and out of startup before the load step occurs

You may need to un-click **Stop simulating if steady state is detected** and specify an end time in Edit Simulation Cmd under the Simulate menu

Simulate a Transformer

Advanced Topic

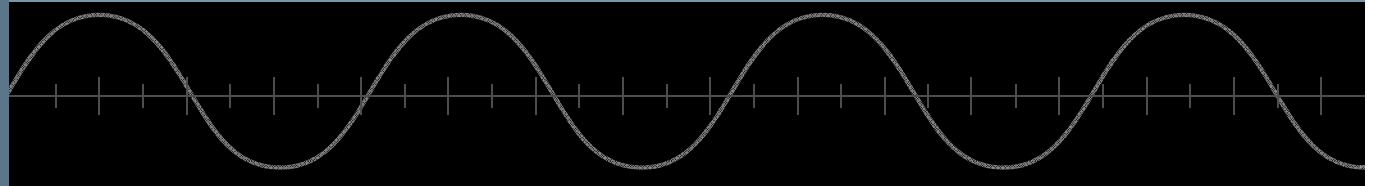

Simulating a Transformer

- ◆ Draw each winding of the transformer as an individual inductor
- ◆ Couple inductors with a mutual inductance statement
 - ◆ Add a SPICE directive of the form `K1 L1 L2 L3 ... 1` to the schematic
 - ◆ Left Click on **Edit** then **SPICE Directive**
 - ◆ Inductors in a mutual inductance will be drawn with a phasing dot
 - ◆ Start initially with a mutual coupling coefficient equal to 1

Transformer with two windings

`K1 L1 L2 1`



K statement coupling the windings

For more information check out LTC1871 demo circuit and page 23-24 of September 2006 LT Magazine at www.linear.com

1:3 turns ration gives a 1:9 inductance ratio

Note: winding inductance ratio is the square of the turns ratio

Additional Information and Support

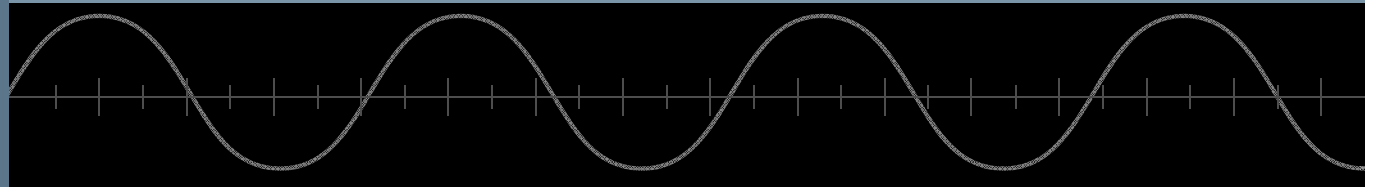

Reminder to Periodically Sync Release

- ◆ Update your release of LTspice to get the latest
 - ◆ Software updates
 - ◆ Models and examples

Sign up for *Linear Insider* via MyLinear (www.linear.com) for email news and updates

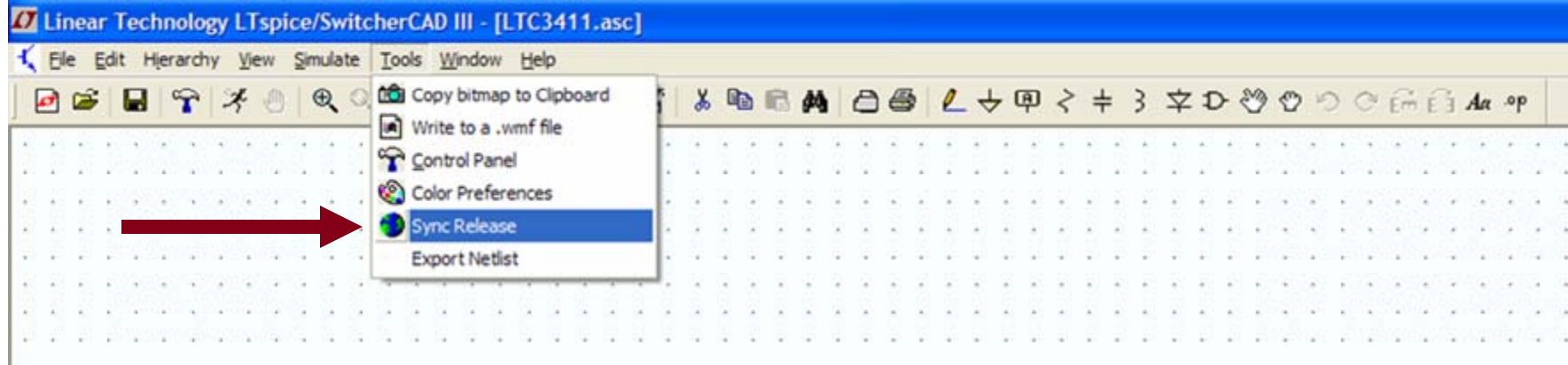

List of changes are available in the changelog.txt that is located in your LTspice root directory (C:\Program Files\LTC\SwCADIII)

Built-in Help System

- ◆ Left Click on **Help** menu and then **Help Topics**

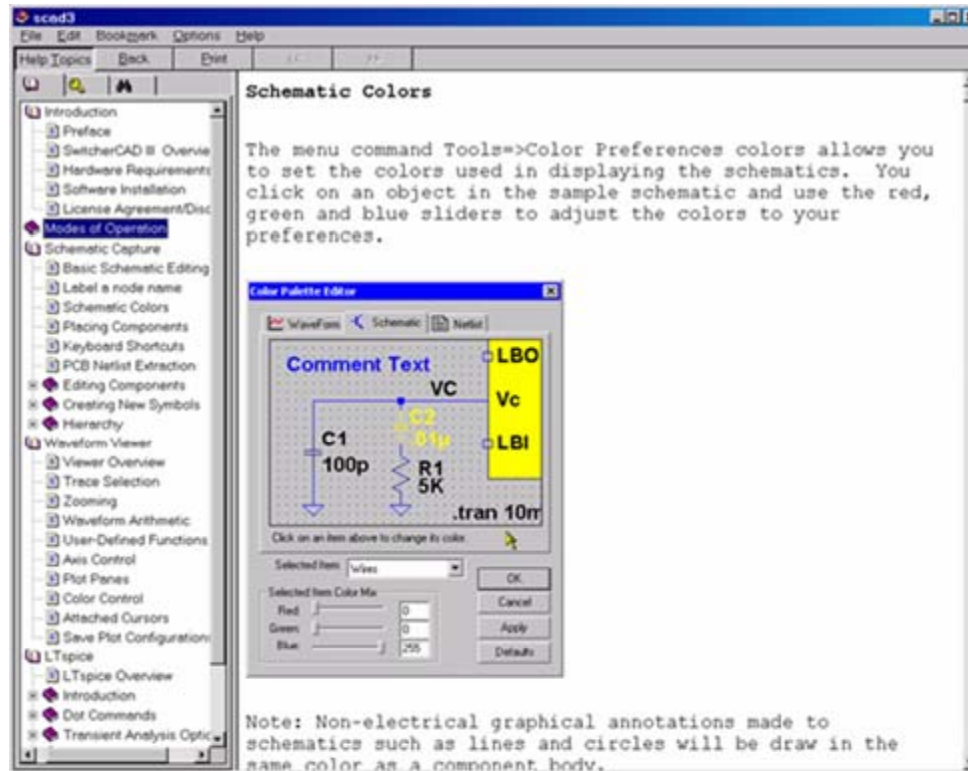

To print out a hardcopy, download user guide at
<http://LTspice.linear.com/software/scad3.pdf>

Emailing Comments and Signing up for Linear Insider

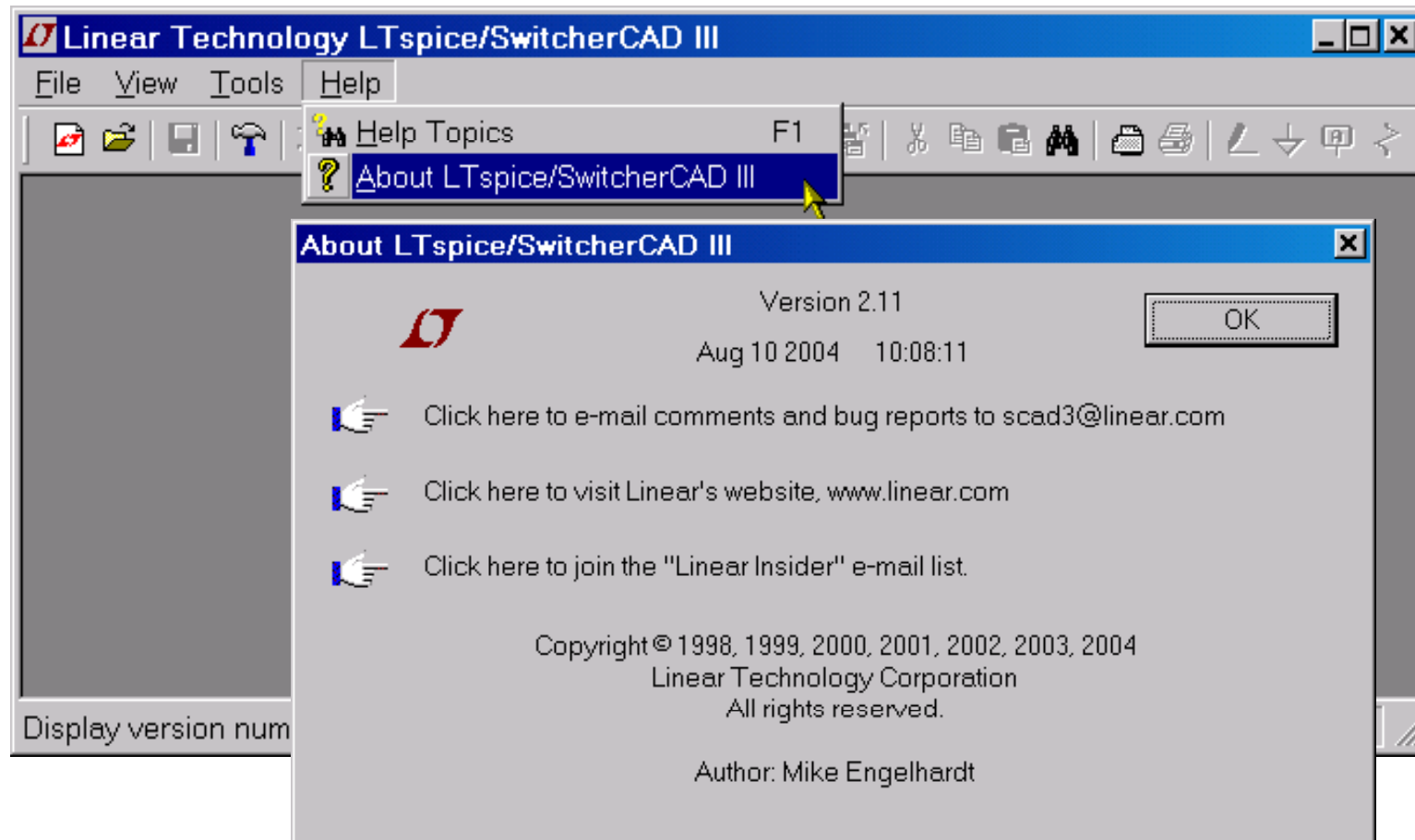

Customer Support

- ◆ *Linear Technology customers* can obtain support by
 - ◆ Calling your local field applications engineer
 - ◆ <http://www.linear.com/contact/>
 - ◆ Calling +1 (408) 432 – 1900 for factory application support
- ◆ *Additional support* (not related to Linear Technology circuits or models support)
 - ◆ Built-in help topics & User Manual
 - ◆ Independent LTspice users' group (search messages)

Simulation with the supplied models is fully supported
All bug reports are appreciated and will be resolved

Independent LTspice Users' Group

- ◆ The group has a section of **files** and **messages** with additional tutorials, libraries, and examples
 - ◆ <http://groups.yahoo.com/group/LTspice/>
- ◆ Join LTspice Users' Group
 - ◆ Email LTspice-subscribe@yahoogroups.com
 - ◆ Subject=Subscribe

The screenshot shows the Yahoo! Groups page for the LTspice Users' Group. The page title is "LTspice - LTspice/SwitcherCAD III". The main content area includes a "Home" section with activity statistics: "Activity within 7 days: 103 New Members - 169 New Messages - 29 New Files - New Questions". Below this is a "Description" section that reads: "Dedicated to the exchange of information about LTspice. LTspice/SwitcherCAD III (download now) is a complete and fully functional SPICE program that is available free of charge from Linear Technology. Before using the software, please read the License Agreement found in the introductory LTspice Help pages. Please report bugs directly to LTC. The program includes the correct address for that on its Help>About dialog box (Menu command Help>> About LTspice/SwitcherCAD III). You will need to include any relevant files and a note on how to duplicate the problem. For general questions, please read the program Help file, the group FAQ and try the group message Search before posting. If you post questions about a specific circuit, it is most helpful to also upload the schematic file (.asc) and any necessary symbol (.asy) and model files to the Files/Temp folder. Never upload the big output file (.raw) of a simulation. Yahoo Groups allow you to easily correct or delete any upload mistakes. A list of all uploaded files can be found in Files/All Files Index. It is 'members only' to help avoid spammers. Please avoid personal attacks. The Group Moderators have no affiliation with Linear Technology." To the right of the text is a screenshot of the LTspice software interface showing a circuit schematic and a simulation plot. The bottom of the page has a search bar and a "Most Recent Messages" section.